

EchoPulse®

Radar Liquid Level Transmitter



LR10, LR15, LR20, LR25 & LR30 Series Quick Start



©2020 Flowline, Inc.
All Rights Reserved

WELCOME TO THE ECHOPULSE® QUICK START

The EchoPulse® Quick Start Guide is meant to show the basic configuration settings to get the EchoPulse® up and running quickly. If you run into an issue that is not addressed here or wish to install or set up with a non-standard configuration, please address the EchoPulse® Manual or refer to the Flowline website at www.flowline.com.

WE DO YOUR LEVEL BEST

Thank you for purchasing EchoPulse®. The sensor provides level measurement for your tank application. This Quick Start includes everything you'll need to get the sensor up and running.

SENSOR MODELS

Offered in five different models, EchoPulse® a general-purpose, two-wire, pulse radar level sensor that provides a continuous 4-20 mA current output proportional to the liquid level in a tank or sump. Make sure that the model purchased is appropriate for your application.

Series	Max Range	Beam Angle	Material	Mounting	FCC Compliance	Application
LR10	32.81' (10m)	22°	PFA	1-1/2" NPT	Part 15.209, Class A	Corrosive liquids under simple process conditions
LR15	98.42' (30m)	18° (2" horn)	316L SS	1-1/2" NPT	Part 15.209, Class A	Storage tanks & process tanks under difficult process conditions
		12° (3" horn)			Part 15.256, Class B	
		8° (4" horn)			Part 15.256, Class B	
LR20	65.61' (20m)	12° (3" Flange)	316L SS with PTFE cover	3" ANSI flange	Part 15.256, Class B	Aggressive liquids under extremely difficult process conditions
		8° (4" flange)		4" ANSI flange		
LR25	114.83' (35m)	20°	316L SS with PTFE cover	4" ANSI or 6" ANSI flange	Part 15.209, Class A	Storage tank & process tanks under extremely difficult process conditions
LR30	98.42' (30m)	12°	PA66	Bracket or top mounted (1" conduit)	Part 15.256, Class B	Water processing, lift stations, storm water and sump process conditions

FCC CONFORMITY

- ⚠ This instrument complies with Part 15 of the FCC Rules. Operation is subject to the following two conditions: (1) this instrument may not cause harmful interference, and; (2) this instrument must accept any interference received, including interference that may cause undesired operation.
- ⚠ Changes or modifications not expressly approved by the manufacturer could void the user's authority to operate the equipment.
- ⚠ **Warning:** User must keep a safety distance of at least 20cm from the antenna.
- ⚠ **Note: LR10, LR15 (2" horn) & LR25 Series:** This equipment has been tested and found to comply with the limits for a Class A digital device, pursuant to part 15 of the FCC Rules. These limits are designed to provide reasonable protection against harmful interference when the equipment is operated in a commercial environment. This equipment generates, uses, and can radiate radio frequency energy and, if not installed and used in accordance with the instruction manual, may cause harmful interference to radio communications. Operation of this equipment in a residential area is likely to cause harmful interference in which case the user will be required to correct the interference at their own expense.
 - This equipment is not allowed to be connected to public utility power lines.
- ⚠ **NOTE: LR15 (3" & 4" horn), LR20 & LR30 Series:** This equipment has been tested and found to comply with the limits for a Class B digital device, pursuant to Part 15 of the FCC Rules. These limits are designed to provide reasonable protection against harmful interference in a residential installation. This equipment generates uses and can radiate radio frequency energy and, if not installed and used in accordance with the instructions, may cause harmful interference to radio communications. However, there is no guarantee that interference to radio and television reception, which can be determined by turning the equipment off and on, the user is encouraged to try to correct the interference by one or more of the following measures:
 - Reorient or relocate the receiving antenna.
 - Increase the separation between the equipment and the receiver.
 - Connect the equipment into an outlet on a circuit different from that to which the receiver is connected.
 - Consult the dealer or an experienced radio/TV technician for help.

USING THE DISPLAY

The display module features a dot matrix LCD display with 4 push buttons on a removable puck. Out of the box, the display indicates level in feet and depicts the level within the 4-20mA span on a bar graph at the right side of the display. The four buttons perform the following functions:

<ul style="list-style-type: none"> • ESCAPE <ul style="list-style-type: none"> ○ Exit configuration mode ○ Return to a higher menu level ○ Display Echo Curve 	<ul style="list-style-type: none"> • Up Arrow <ul style="list-style-type: none"> ○ Modify parameter values ○ Choose display mode
<ul style="list-style-type: none"> • Right Arrow <ul style="list-style-type: none"> ○ Choose configuration options ○ Choose parameter digits to edit ○ Display contents of parameters 	<ul style="list-style-type: none"> • ENTER <ul style="list-style-type: none"> ○ Enter Menu and Options ○ Confirm configuration options ○ Confirm changes to parameters



MENU INTRODUCTION

- 1) To enter the Main Menu (from the Main Screen), press the **ENTER** button.
- 2) Use the **Right Arrow** button to scroll through the Main Menu options.
 - a) Configuration - Below are the configuration menu functions:
 - i) Empty Configuration
 - ii) Full Configuration
 - iii) Medium
 - iv) Dampening
 - v) Output Mapping
 - vi) Scaled Units
 - vii) Scaling
 - viii) Range
 - ix) Dead Band
 - x) Sensor ID
 - b) Display - This menu function sets the display mode and contrast.
 - c) Diagnostics - Below are the diagnostic menu functions:
 - i) Measurement of Peak Values
 - ii) Measurement Status
 - iii) Echo Curve
 - iv) Simulation
 - d) Service - Within the service menu functions, you can store a False Echo Curve, set units of measurement, change output settings, reset configuration settings, set language or set a PIN for the sensor.
 - e) Info - This item provides information on the sensor's type, serial number, date of manufacture and software version.
- 3) To select one of the functions, press **ENTER**.
- 4) To exit the programming mode, press **ESC**.

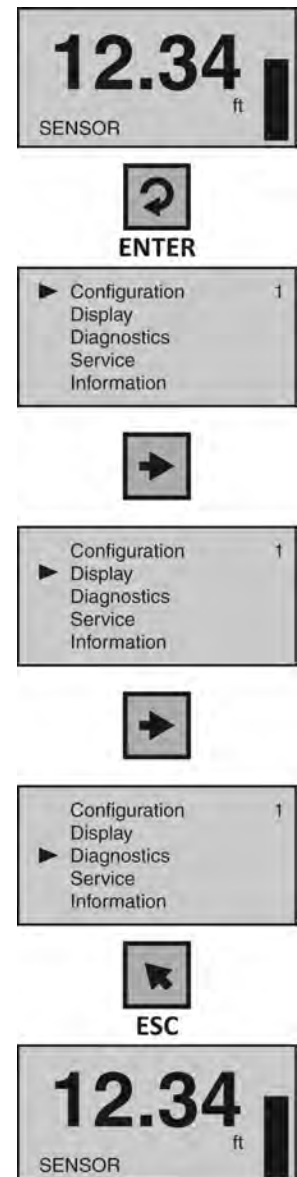

BASIC CONFIGURATION OVERVIEW

Below are the 9 basic steps to configure the sensor for operation. Each step is described in detail on the following pages

1) Measure the Tank

- a) Begin by measuring the key tank and fitting dimensions. Correct tank dimensions will result in accurate sensor measurement.

2) Set the Units of Measurement

- a) Units can be configured in basic engineering units of length including Feet or Meters.

3) Set the Empty Configuration

- a) This is the empty setting (4mA) for the tank.

4) Set the Full Configuration

- a) This is the full setting (20mA) for the tank.

5) Set the Range (Maximum Range or MaxR)

- a) This is the maximum measurement range for the sensor. The sensor will ignore all echo returns beyond this setting.

6) Set the Dead Band (Minimum Range or MinR)

- a) This is the minimum measurement range for the sensor. The sensor will ignore all echo returns closer than this setting.

7) Check the Echo Curve

- a) This is a quick diagnostic tool to determine if the sensor is reading the correct level.

8) Install the Sensor

- a) Review the installation requirements to assist in the mounting of the sensor.

9) Wire the Sensor

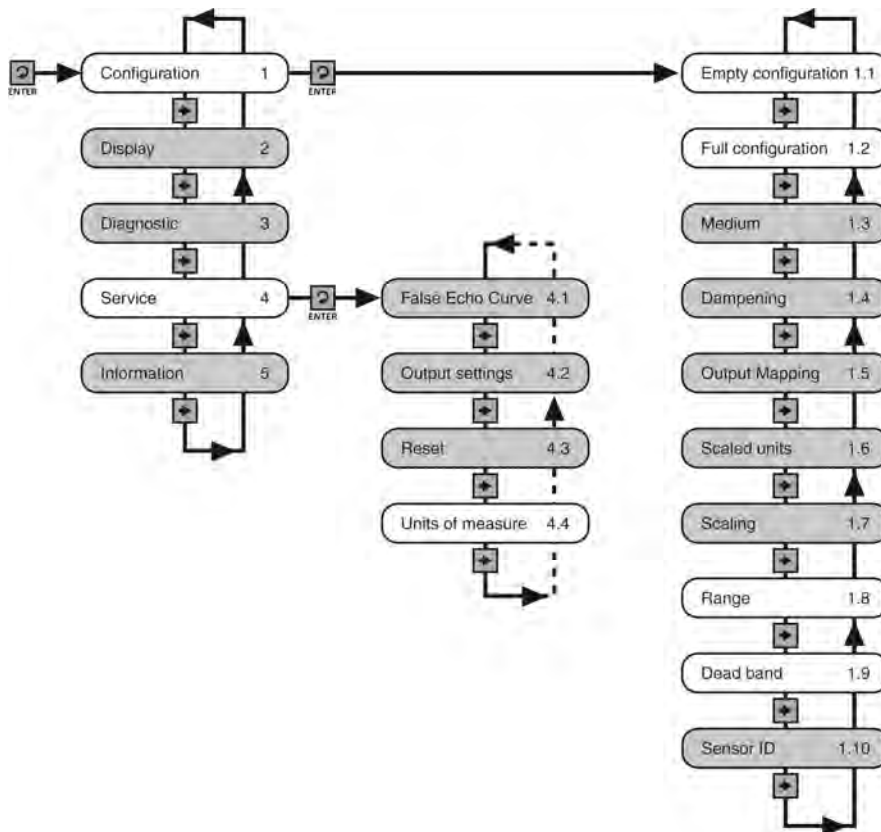

STEP 1 – MEASURE THE TANK

Measuring the tank is one of the most important aspects in configuring the sensor. When measuring the tank, take into account the location of the sensor with respect to fittings, risers, dome tops and bottoms, and identify where the measurements are taken from the sensor. **Note:** The location for measurement may be different among different sensor Series, based upon the type of antenna. Refer to the Measurement Reference Chart for the measurement location of your sensor. The basic measurements for configuration are described below:

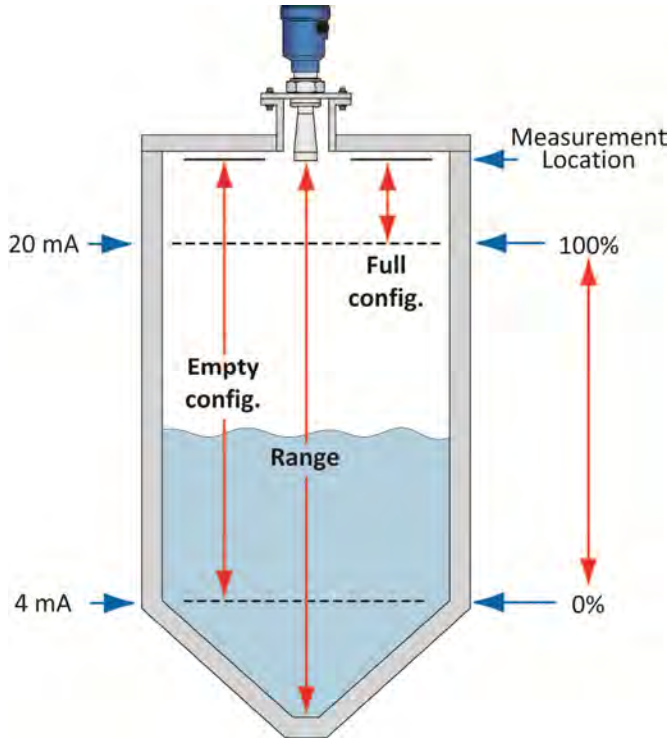

- 1) Distance from the sensor's measurement location to the bottom of the tank is the **Range** value. The Range value is typically set at the bottom of the tank.
- 2) Distance from the sensor's measurement location to the empty or lowest liquid level in the tank is the **Empty Configuration**.
 - a) Empty Configuration = 4mA setting.
 - b) With flat bottom tanks, the Range and Empty Configuration values can be the same.
- 3) Distance from the sensor's measurement location to the full or highest liquid level in the tank is the **Full Configuration**.
 - a) Full Configuration = 20mA setting.

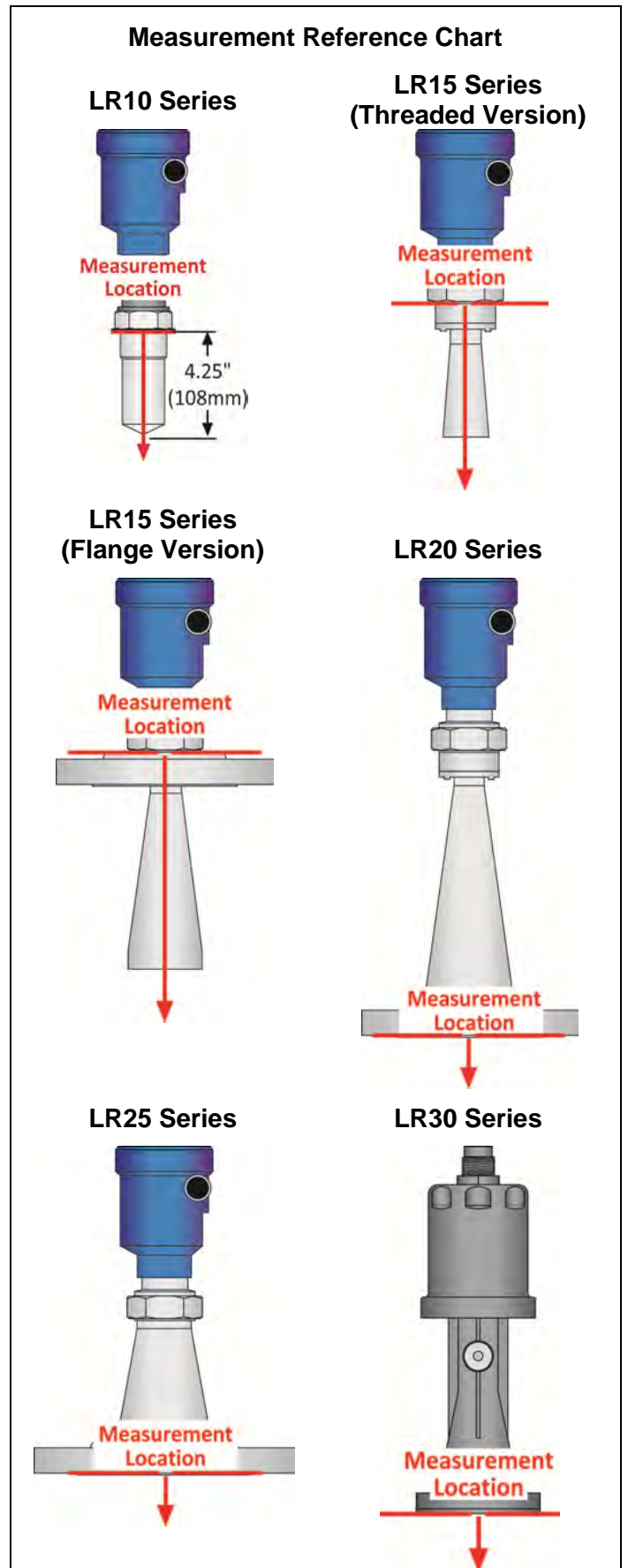

CONE BOTTOM TANKS

When installing the EchoPulse® on a tank with a cone bottom, the geometry of the bottom part of the tank can influence the sensor's configuration. If your requirement is to measure into the cone, location of the sensor is critical. However, if your requirement is only for the straight side of the tank, the location of the sensor is not critical.

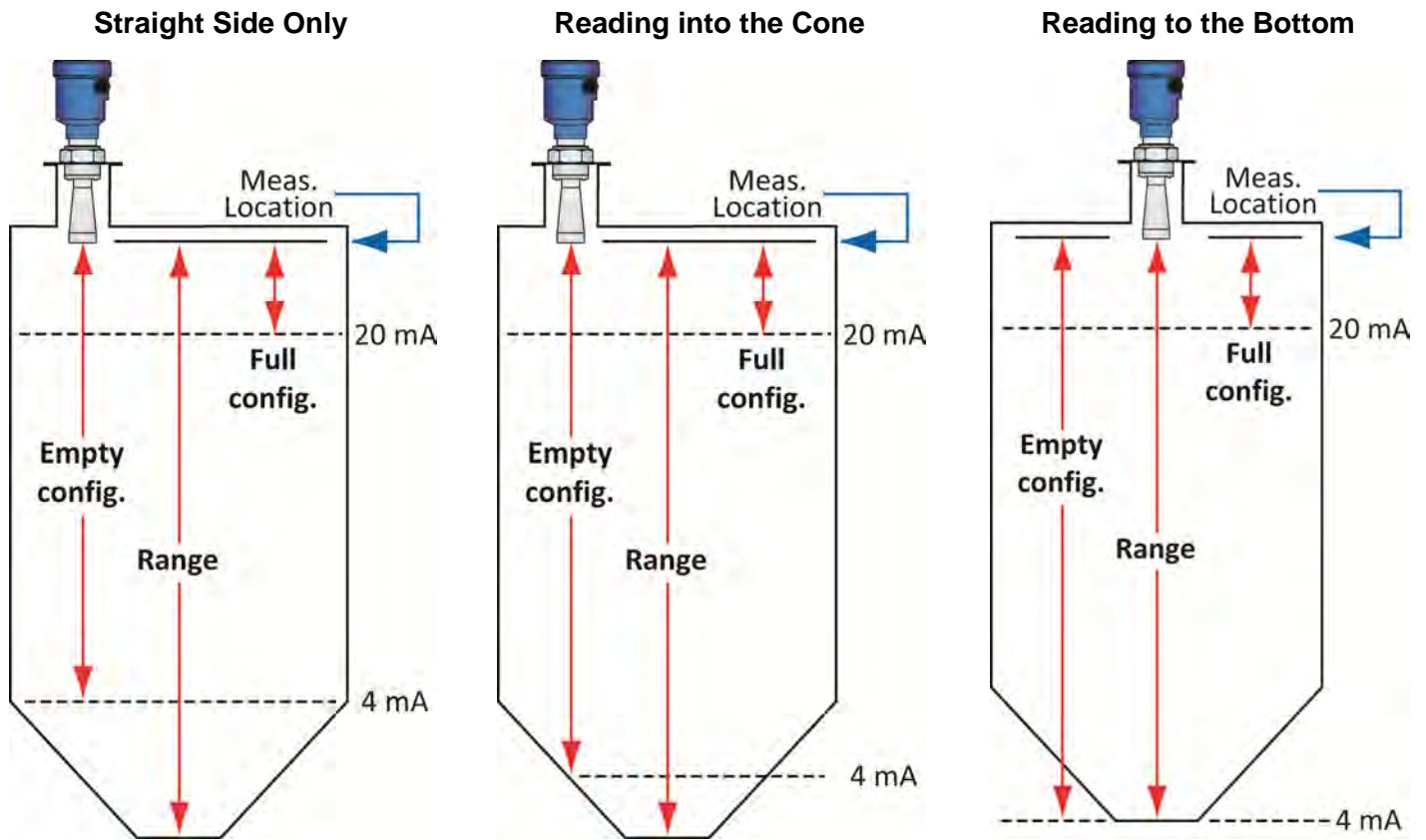

The location of the sensor is not critical because the lowest level reading is within the straight side of the tank.

Sensor can read into the cone, but only to where the majority of energy reflects back to the sensor and not away from the sensor.

Sensor must be installed over the lowest part of the tank in order to provide the best path allowing energy to travel down to the tank bottom.

TOP OF TANK CONSIDERATIONS

Below are some considerations with respect to how the sensor can be installed on top of a tank. EchoPulse® has a dead band that extends from the measurement location of the sensor. As a result, the height of the sensor above or below the top of the tank will affect the dead band and 20mA settings.

Directly on Top of Tank

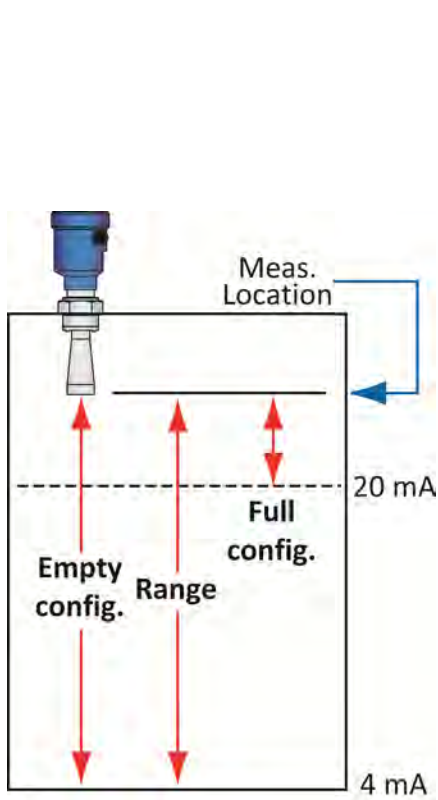

Small Riser, Horn within Tank

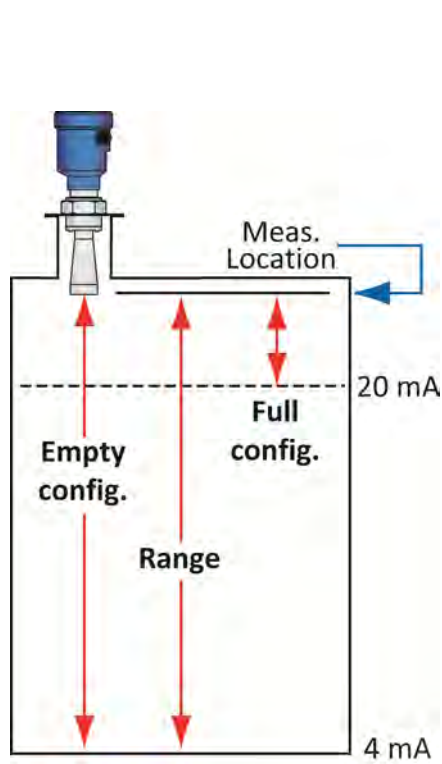

Tall Riser, Horn inside Riser

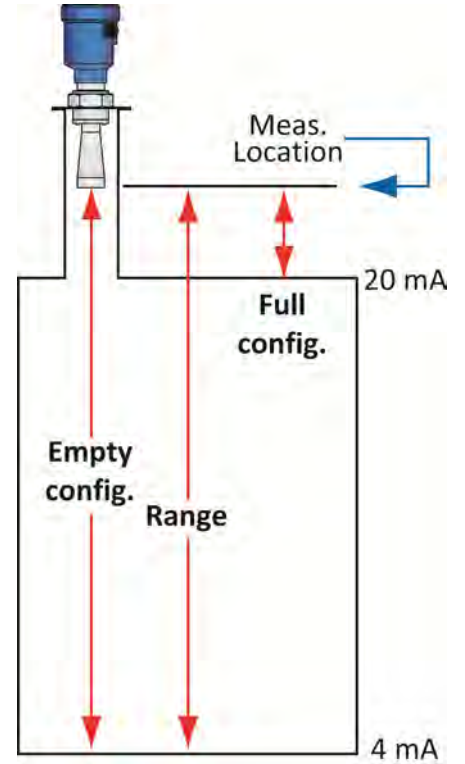

STEP 2 – SET THE UNITS OF MEASUREMENT

This function sets the units for all measurement values to be entered into the sensor. The choices for units are feet and meters. The unit is shipped with a default setting of feet.

1. From the Main Screen, press **Enter** to advance into the Main Menu.
2. Press **Right Arrow** repeatedly until the arrow is next to Service.
3. Press **Enter** to advance into the Service menu (Echo curve will appear).
4. Press **Right Arrow** repeatedly until the menu shows Units of Measurement.
5. Press **Enter** to advance into Units of Measurement.
6. Press **Right Arrow** to change the setting between feet [ft (d)] and meters [m (d)].

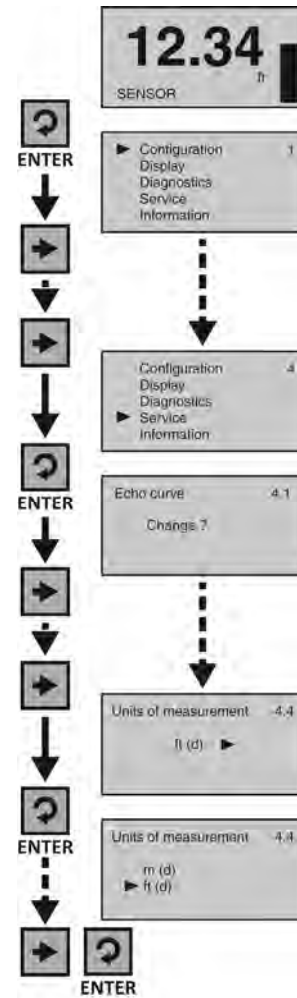

7. When the units are correct, press **Enter** to save the setting.
8. When done, press **ESC** to return to the Main Menu, and press **ESC** a second time to return to the Main Screen.

STEP 3 – SET THE EMPTY CONFIGURATION (4mA)

This function sets the Empty Configuration point for the sensor. This point corresponds to 4mA being tank empty. **Note:** this setting is based upon the distance from the sensor's measurement location to the tank empty location. The value for the setting will be a larger number than the Full Configuration because we are measuring from the top of the tank down.

1. From the Main Screen, press **Enter** to advance into the Main Menu.
2. Press **Enter** to advance into the Configuration Menu.
3. Press **Enter** to advance into Empty Configuration. The first percentage segment will be highlighted.
4. Press **Enter** again to switch to the distance (d) setting.
5. Press **Right Arrow** to move one segment to the right. **Right Arrow** will scroll left to right and then back to the first segment.
6. Press **Up Arrow** to increase the value of the number highlighted. **Up Arrow** will scroll from 0 to 9 and back again.
7. When the value is correct, press **Enter** to save the setting.
8. When done, press **ESC** to return to the Main Menu, and press **ESC** a second time to return to the Main Screen or; if you want to advance directly into Full Configuration, press **Right Arrow**.

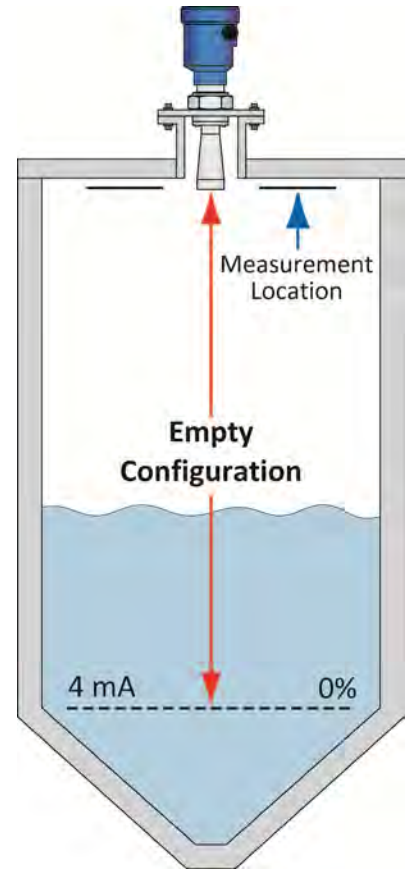
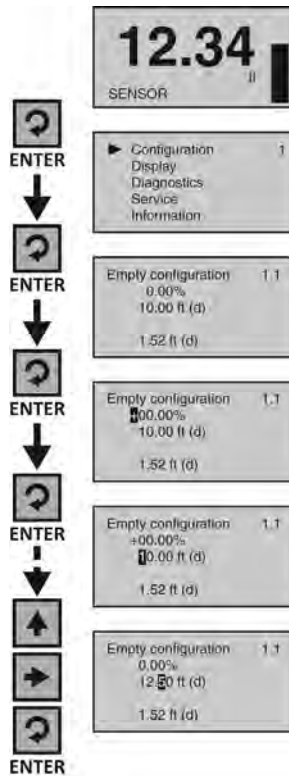

STEP 4 – SET THE FULL CONFIGURATION (20mA)

This function sets the Full Configuration point for the sensor. This point corresponds to 20mA being tank full. **Note:** this setting is based upon the distance from the sensor’s measurement location to the tank full location. The value for the setting will be a smaller number than the Empty Configuration because we are measuring from the top of the tank down.

1. From the Main Screen, press **Enter** to advance into the Main Menu.
2. Press **Enter** to advance into the Configuration Menu.
3. Press **Right Arrow** to advance into Full Configuration.
4. Press **Enter** to advance into Full Configuration. The first percentage segment will be highlighted.
5. Press **Enter** again to switch to the distance (d) setting.
6. Press **Right Arrow** to move one segment to the right. **Right Arrow** will scroll left to right and then back to the first segment.
7. Press **Up Arrow** to increase the value of the number highlighted. **Up Arrow** will scroll from 0 to 9 and back again.
8. When the value is correct, press **Enter** to save the setting.
9. When done, press **ESC** to return to the Main Menu, and press **ESC** a second time to return to the Main Screen or; if you want to advance directly into Range, press **Right Arrow** repeatedly until Range appears.

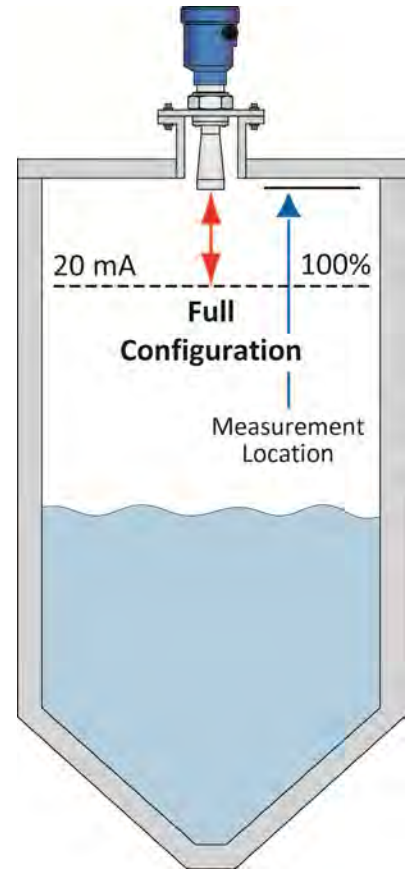
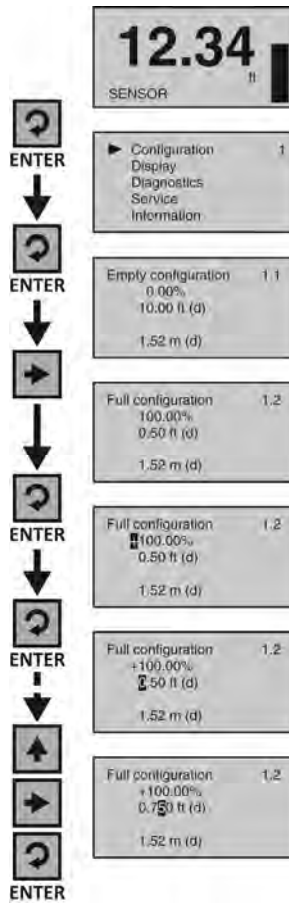

STEP 5 - SET THE RANGE (MAXIMUM RANGE)

This function sets the maximum operational range (MaxR) for the sensor. This setting defines the maximum distance that the sensor will detect valid echo returns. **Note:** this setting is typically equal to or greater than the Empty Configuration setting. Setting the Maximum Range to a value less than the Empty configuration will prevent the sensor from reaching the tank empty (4mA).

1. From the Main Screen, press **Enter** to advance into the Main Menu.
2. Press **Enter** to advance into the Configuration Menu.
3. Press **Right Arrow** repeatedly until the menu shows Range.
4. Press **Enter** to edit Range value. The first segment will be highlighted.
5. Press **Right Arrow** to move one segment to the right. **Right Arrow** will scroll left to right and then back to the first segment.

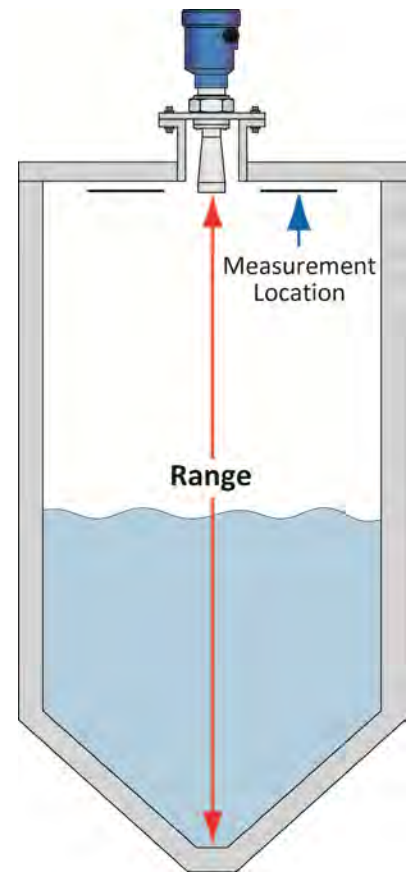
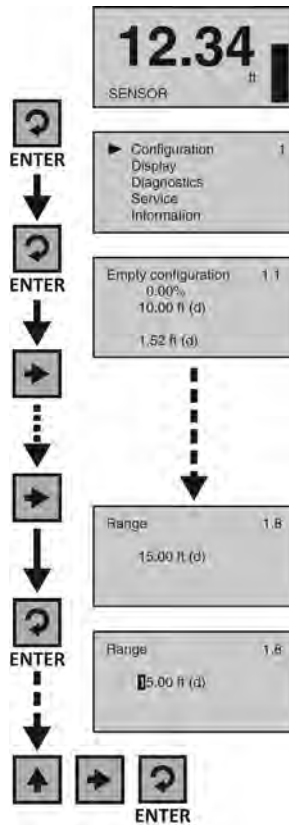

6. Press **Up Arrow** to increase the value of the number highlighted. **Up Arrow** will scroll from 0 to 9 and back again.
7. When the value is correct, press **Enter** to save the setting.
8. When done, press **ESC** to return to the Main Menu, and press **ESC** a second time to return to the Main Screen or; if you want to advance directly into Dead Band, press **Right Arrow** repeatedly until Dead Band appears.

STEP 6 - SET THE DEAD BAND

This function sets the Dead Band for the sensor. This setting defines the minimum distance that the sensor will detect valid echo returns. While the Dead Band setting is typically configured to be equal with or slightly above (higher in the tank) than the Full Configuration setting (20 mA), it functions independently of Full Configuration. **Note:** If the Dead Band setting is placed below the Full Configuration setting, then the sensor will not measure above the Dead Band.

Dead Band Equals Full Config.

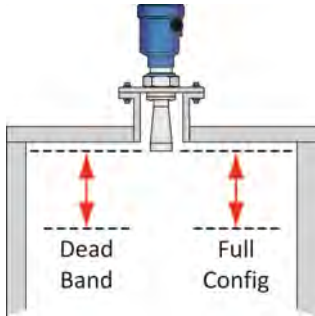

Dead Band Below Full Config.

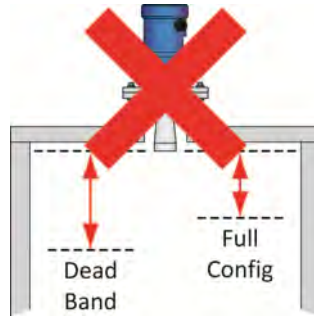

Dead Band Above Full Config.

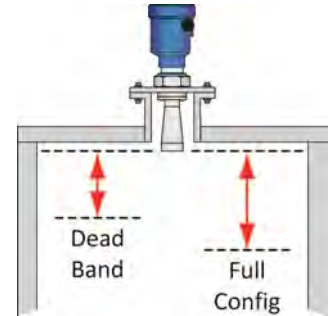

1. From the Main Screen, press **Enter** to advance into the Main Menu.
2. Press **Enter** to advance into the Configuration Menu.
3. Press **Right Arrow** repeatedly until menu shows Dead Band.
4. Press **Enter** to edit Dead Band value. The first segment will be highlighted.
5. Press **Right Arrow** to move one segment to the right. **Right Arrow** will scroll left to right and then back to the first segment.
6. Press **Up Arrow** to increase the value of the number highlighted. **Up Arrow** will scroll from 0 to 9 and back again.
7. When the value is correct, press **Enter** to save the setting.
8. When done, press **ESC** to return to the Main Menu, and press **ESC** a second time to return to the Main Screen.

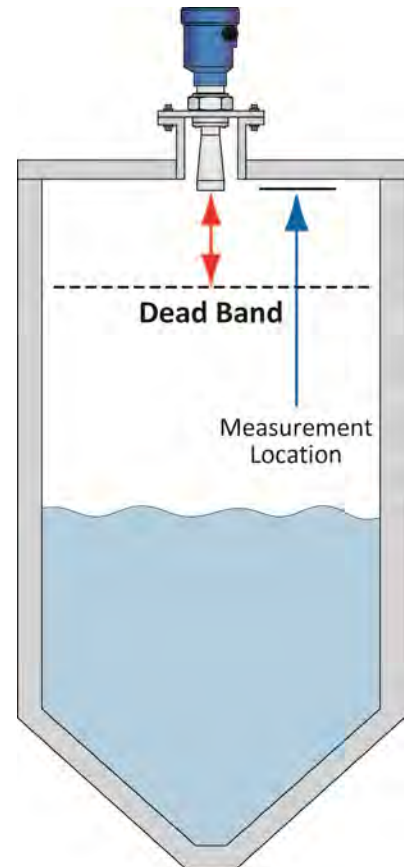
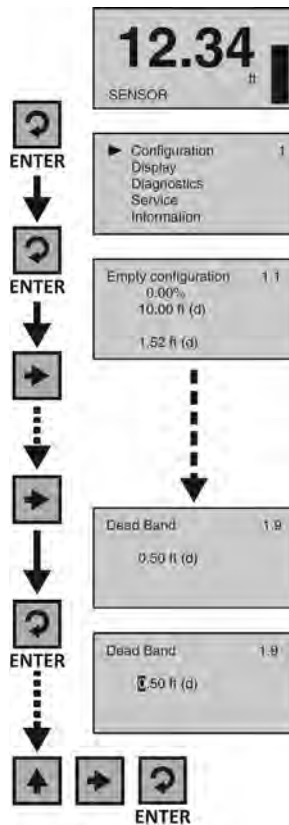

STEP 7 – CHECK THE ECHO CURVE

This function displays the primary echo return(s) that the sensor is seeing graphically, the location and amplitude of the return(s), and the numeric air gap distance from the sensor's measurement location to the liquid level below.

Note: This step should only be performed after having completed the prior six configuration steps with the sensor installed on the tank. Additionally, if the sensor was installed in a stand pipe or sight glass, now go forward to Section Six and turn on the still well function (Sensor Installed in a Stand Pipe or Sight Glass) before continuing with this step.

1. From the Main Screen, press **ESC** and the Echo Curve Screen will appear. The curve graphically represents the primary echo return(s) amplitude (Y-axis) over distance (X-axis). Above the echo return peak is a floating arrow and triangle symbol (which under normal conditions are often merged together or seen as a single triangle because it's the larger of the two symbols). The arrow represents the measured liquid level and the triangle represents the peak amplitude location of the echo return. Under normal conditions, expect to see a stable triangle (or overlapping arrow and triangle) floating above a pronounced peak at the expected air gap distance between the measurement location and liquid level.
2. In the upper right hand corner of the screen are two lines of numbers that represent the air gap distance from the measurement location to the liquid level (arrow) on the top, and peak amplitude location (triangle) of the echo return on the bottom. Under normal conditions, these values should be relatively close to one another and consistent with the expected air gap distance between the measurement location and liquid level.
3. Assuming that the sensor is properly installed, if the measured liquid level and peak amplitude location data (symbols and values) are unstable, substantially different from one another and/or inconsistent with the actual air gap distance, then this likely indicates that the sensor requires additional process adjustment(s) described in the following Section Six.
4. When done, press **ESC** to return to the Main Menu.

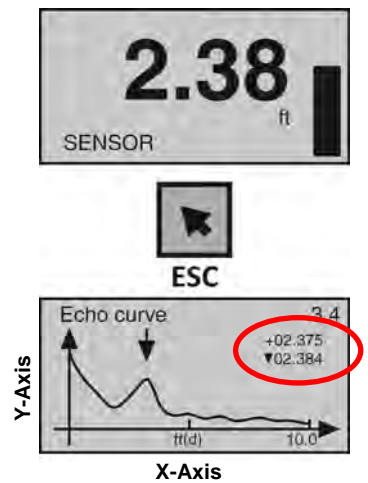

STEP 8 – INSTALL THE SENSOR (INSTALLATION REQUIREMENTS)

EchoPulse® measures the distance between the sensor and the liquid surface below. Typically, all measurements from the sensor originate from the bottom of the antenna. Refer to the Measurement Reference Chart to determine the location where measurement originates on your sensor. To ensure reliable measurement, adhere to the following minimum installation requirements:

- 1) There are no obstructions between the bottom edge of the installed antenna and the surface of the liquid below including ladders, walls, tank seams, liquid inflows, rails, other sensors, mixer blades, heating coils, pumps, struts or apparatus.

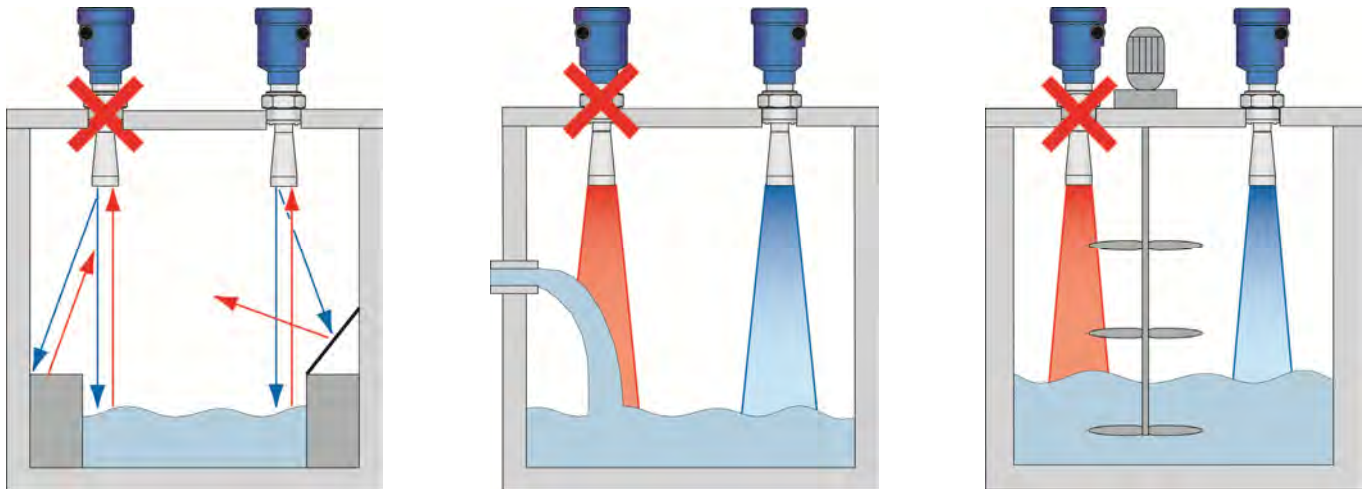

- Note:** Additionally, when the sensor transmits a microwave pulse, the RF signal spreads in a conical shape (determined by its beam angle) over distance. Refer to the Beam Angle Chart to determine, what if any, additional measurement space is required to be free of such obstacles. If such items are present, then a False Echo Curve configuration must be done (Section Seven).

Beam Angle	8°	12°	18°	20°	22°	24°
Height	Dia.	Dia.	Dia.	Dia.	Dia.	Dia.
10'	1.40'	2.10'	3.17'	3.53'	3.89'	4.25'
20'	2.80'	4.20'	6.34'	7.05'	7.78'	8.50'
30'	4.20'	6.31'	9.50'	10.58'	11.66'	12.75'
40'	5.59'	8.41'	12.67'	14.11'	15.55'	17.00'
50'	6.99'	10.51'	15.84'	17.63'	19.44'	21.26'
60'	8.39'	12.61'	19.01'	21.16'	23.33'	25.51'
70'	9.79'	14.71'	22.17'	24.69'	27.21'	29.76'
80'	11.19'	16.82'	25.34'	28.21'	31.10'	34.01'
90'	12.59'	18.92'	28.51'	31.74'	34.99'	38.26'
100'	13.99'	21.02'	31.68'	35.27'	38.88'	42.51'

Beam Angle	8°	12°	18°	20°	22°	24°
Height	Dia.	Dia.	Dia.	Dia.	Dia.	Dia.
5m	0.70m	1.05m	1.58m	1.76m	1.94m	2.13m
10m	1.40m	2.10m	3.17m	3.53m	3.89m	4.25m
15m	2.10m	3.15m	4.75m	5.29m	5.83m	6.38m
20m	2.38m	4.20m	6.34m	7.05m	7.78m	8.50m
25m	3.50m	5.26m	7.92m	8.82m	9.72m	10.63m
30m	4.20m	6.31m	9.50m	10.58m	11.66m	12.97m

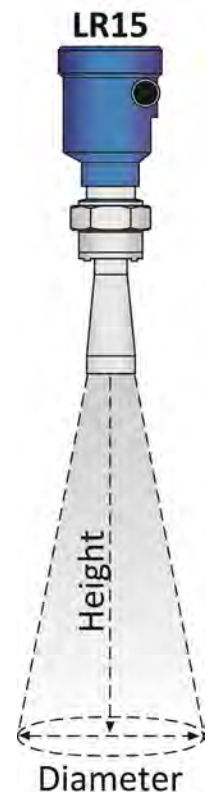

- 2) The sensor must be installed with the antenna perpendicular to the surface of the liquid.
- 3) The sensor must be installed with a distance $\geq 19.7"$ (500mm) from the side wall of the tank.
- 4) The liquid level must not be allowed to enter into the dead band (blanking zone) of the sensor.

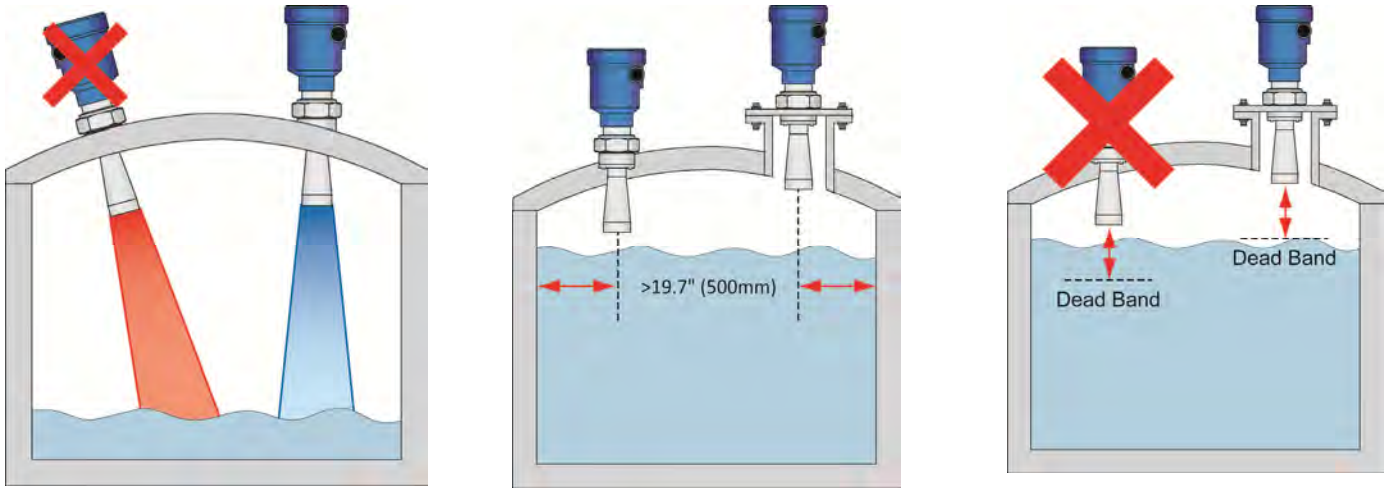

- 5) The sensor installation must be done in accordance with relevant local or federal safety regulations.
- 6) The sensor must be connected to electrical ground.
- 7) Do not use the housing to screw the sensor into the installation fitting (LR10 & LR15 Series).
 - a) Applying a tightening force against the housing may damage the sensor.
- 8) Make sure that all parts of the sensor exposed to the application, specifically any portion installed within the tank, are suitable for the process.
 - a) Consider any effects from the application temperature, pressure or media.

STEP 9 – WIRE THE SENSOR

Remove the Display: To access the terminal strip and conduit ports, you first need to remove the display. Gently twist the display counter-clockwise until you feel the display unlock from the housing. Next, lift the display from the housing to view the terminal strip and wire access ports. **Note:** This procedure applies to all sensors including the LR30 with its LR98 remote display.

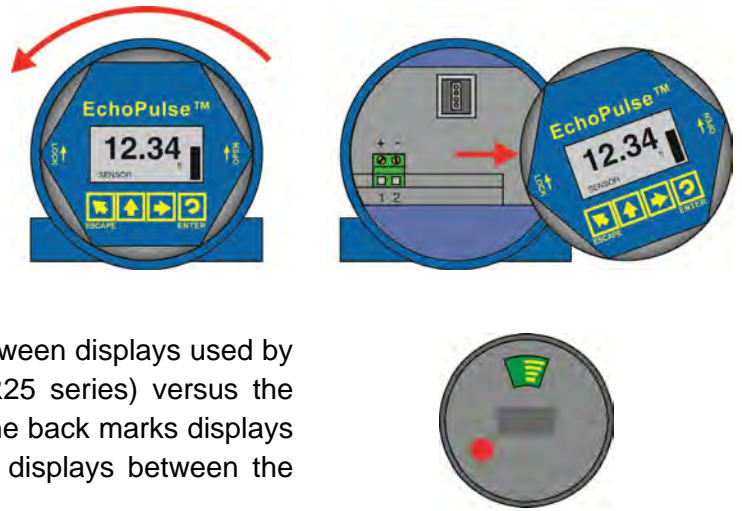

Note: There is an internal configuration difference between displays used by the EchoPulse® sensors (LR10, LR15, LR20 and LR25 series) versus the display used with the LR98 series. A colored dot on the back marks displays to be used only with the LR98 series. Never swap displays between the LR98 series and other EchoPulse® sensors.

Supply Voltage: The sensor power supply and current signal share the same two-wire shielded cable. The sensor supply voltage should never exceed 26 VDC. Always provide complete electrical and physical separation between the sensor supply circuit and the main circuit. **Note:** Remember that the output voltage of the power supply can be lower under nominal load (with a sensor current of 20.5 mA or 22 mA) and/or with the addition of other instruments placed within the circuit. If voltage spikes or surges are expected, adequate isolation protection must also be provided.

Terminal Wiring: The positive (+) and Negative (-) terminals are for connection to a 24 VDC power supply or to a 4-20 mA loop power source. The wire to the terminals can be extended up to 1,000 feet using 22 gauge or larger wire.

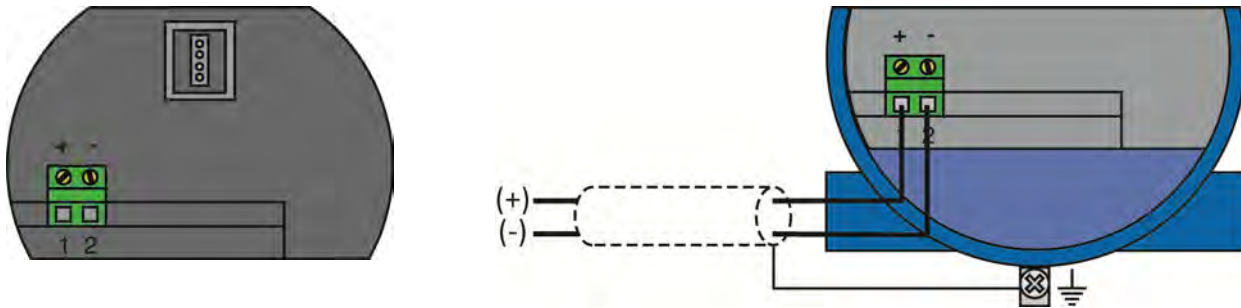

The sensor should be wired with shielded 2-conductor cable (16 to 22 AWG) to protect from electromagnetic interference. If using a liquid tight connector, select a cable with an outer diameter that is designed to ensure an effective seal with the connector [typically between 0.20" to 0.35" (5 to 9 mm)].

ELECTRICAL, USAGE AND SAFETY

1. Wiring should always be done by a licensed electrician in accordance with national, state and local codes.
2. Never use a general purpose (cTUVus) sensor (LR10, LR15, LR20, LR25, LR30 Series) in environments classified as hazardous.
3. Where personal safety or significant property damage can occur due to a spill, the installation must have a redundant fail-safe backup system installed which accounts for sensor and/or power failure.

LR30 SENSOR TO LR98 DISPLAY



The LR98 display is used with the LR30 sensor. The attached 8-conductor sensor cable will wire directly into the display terminals. A shielded two-wire cable (user supplied) is required to provide power to and the current output signal from the display. **Note:** LR98 ships with Liquid Tight Fitting (LM90-1051) and ½" FNPT to M20x1.5 adapter (LR97-S003), attached to the display. Use either type of connection to seal both conduit connections on the display.

LR98 Display Removal

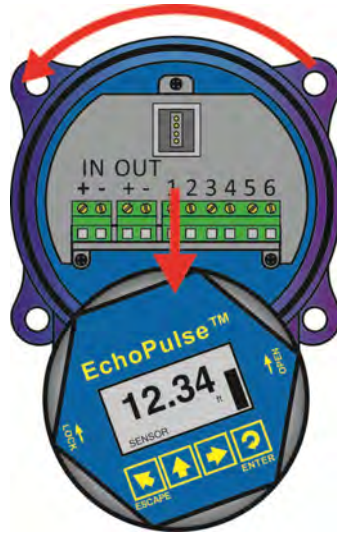

LR98 Display Terminals

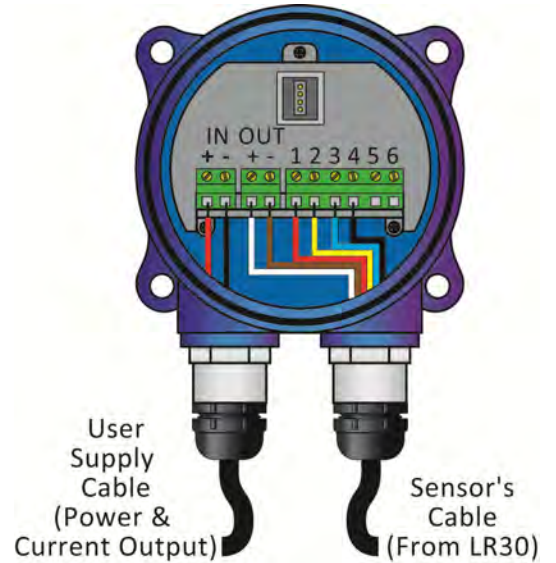

1. Remove the display (as described on the previous page) to access the input and output terminals within the LR98 display.
2. Referencing the below diagram, connect the appropriately colored 6-conductors (of 8 total) from the LR30 sensor cable to Out [(+) & (-)] & terminals 1-4 on the LR98 display.
3. The remaining 2-conductors (Green and Yellow w/ Stripe) will not be used.
4. Finally, connect the 2-conductors (from the user supplied Cable) for loop power input and current output to the (+) and (-) terminals on the LR98 display.

Note: The IN [Positive (+) and Negative (-)] terminals are for connection to a 24 VDC power supply or 4-20 mA loop power source. The 4-20mA wires to the LR98 terminals can be extended up to 1,000 feet using 22-gauge or larger wires. These terminals are equivalent to the (+) and (-) terminals described on the previous page.

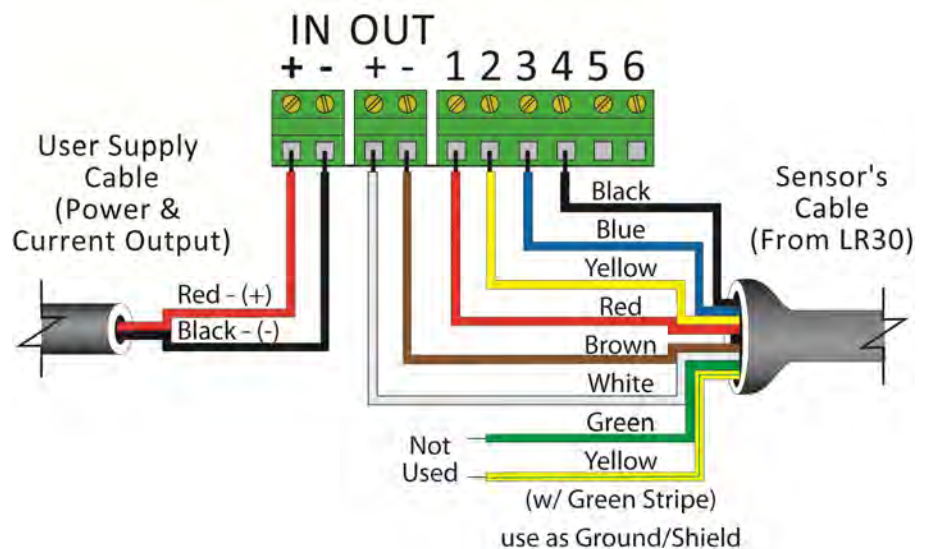

WIRING TO DISPLAYS, CONTROLLERS & PLC's

Below are examples of how to wire EchoPulse™ to common displays, controllers and PLC's.

**DataView™ LI55 Series
Level Controller**

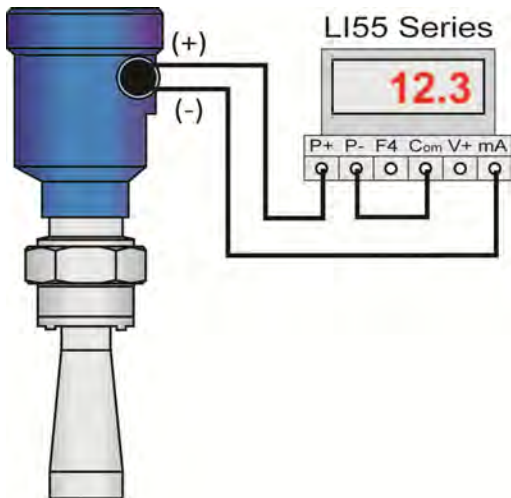

Generic PLC

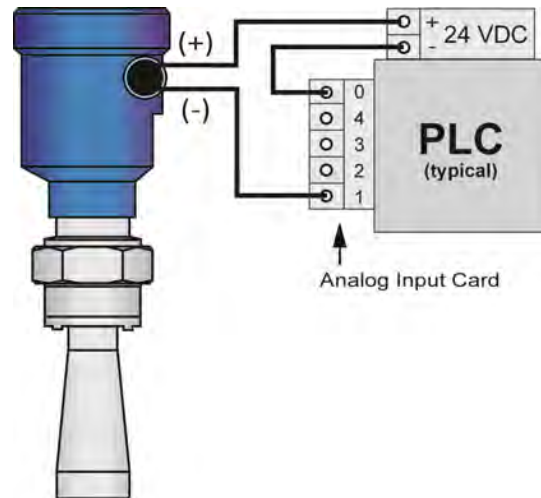

Generic Loop Powered Display

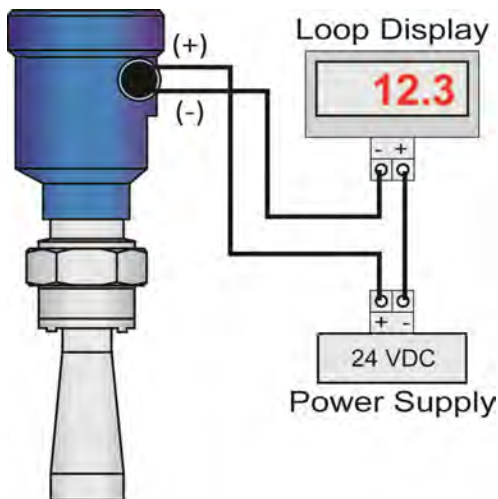

**DataLoop™ LI23 Series Level Indicator
(With Backlight)**

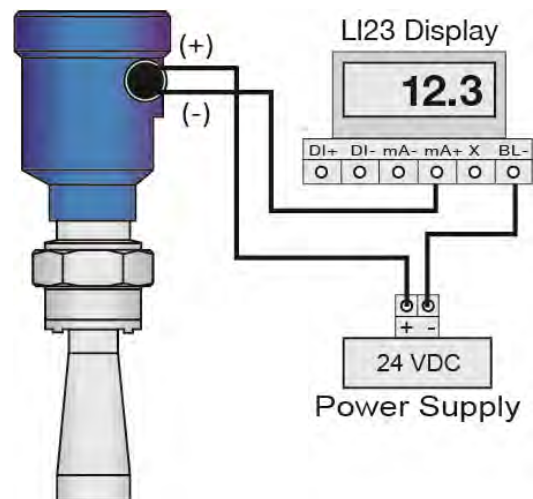

WARRANTY

Flowline warrants to the original purchaser of its products that such products will be free from defects in material and workmanship under normal use and service in accordance with instructions furnished by Flowline for a period of two years from the date of manufacture of such products. Flowline's obligation under this warranty is solely and exclusively limited to the repair or replacement, at Flowline's option, of the products or components, which Flowline's examination determines to its satisfaction to be defective in material or workmanship within the warranty period. Flowline must be notified pursuant to the instructions below of any claim under this warranty within thirty (30) days of any claimed lack of conformity of the product. Any product repaired under this warranty will be warranted only for the remainder of the original warranty period. Any product provided as a replacement under this warranty will be warranted for the full two years from the date of manufacture.

RETURNS

Products cannot be returned to Flowline without Flowline's prior authorization. To return a product that is thought to be defective, go to www.flowline.com, and submit a customer return (MRA) request form and follow the instructions therein. All warranty and non-warranty product returns to Flowline must be shipped prepaid and insured. Flowline will not be responsible for any products lost or damaged in shipment.

LIMITATIONS

This warranty does not apply to products which: 1) are beyond the warranty period or are products for which the original purchaser does not follow the warranty procedures outlined above; 2) have been subjected to electrical, mechanical or chemical damage due to improper, accidental or negligent use; 3) have been modified or altered; 4) anyone other than service personnel authorized by Flowline have attempted to repair; 5) have been involved in accidents or natural disasters; or 6) are damaged during return shipment to Flowline. Flowline reserves the right to unilaterally waive this warranty and dispose of any product returned to Flowline where: 1) there is evidence of a potentially hazardous material present with the product; or 2) the product has remained unclaimed at Flowline for more than 30 days after Flowline has dutifully requested disposition. This warranty contains the sole express warranty made by Flowline in connection with its products. ALL IMPLIED WARRANTIES, INCLUDING WITHOUT LIMITATION, THE WARRANTIES OF MERCHANTABILITY AND FITNESS FOR A PARTICULAR PURPOSE, ARE EXPRESSLY DISCLAIMED. The remedies of repair or replacement as stated above are the exclusive remedies for the breach of this warranty. IN NO EVENT SHALL FLOWLINE BE LIABLE FOR ANY INCIDENTAL OR CONSEQUENTIAL DAMAGES OF ANY KIND INCLUDING PERSONAL OR REAL PROPERTY OR FOR INJURY TO ANY PERSON. THIS WARRANTY CONSTITUTES THE FINAL, COMPLETE AND EXCLUSIVE STATEMENT OF WARRANTY TERMS AND NO PERSON IS AUTHORIZED TO MAKE ANY OTHER WARRANTIES OR REPRESENTATIONS ON BEHALF OF FLOWLINE. This warranty will be interpreted pursuant to the laws of the State of California. If any portion of this warranty is held to be invalid or unenforceable for any reason, such finding will not invalidate any other provision of this warranty.

For complete product documentation, video training, and technical support, go to www.flowline.com.

For phone support, call 562-598-3015 from 8am to 5pm PST, Mon - Fri.

(Please make sure you have the Part and Serial number available.)